

Owlets

Created / 2006
 Difficulty / Intermediate
 Time to Create / 20 min.
 Dimension / R=0.5

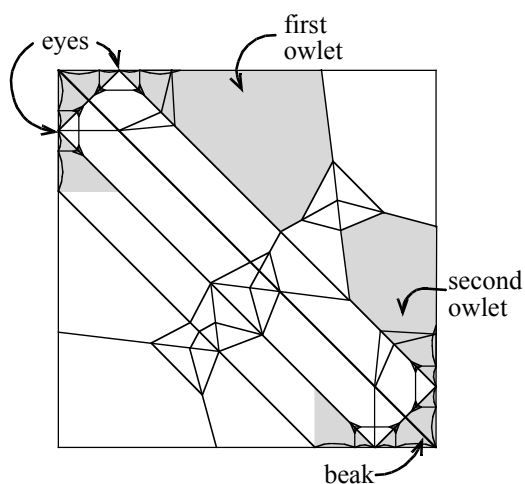

Author's comments: Use a bi-colored square to create this spooky group of 2 owl chicks. I like to wet fold this model from white or black Canson backed with bright green or yellow foil for the face color. Perfect decoration for Halloween!

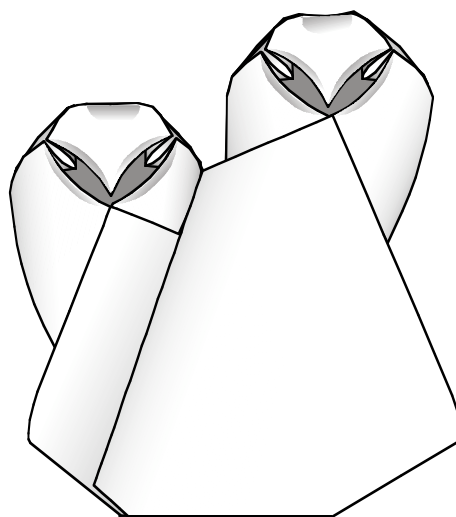
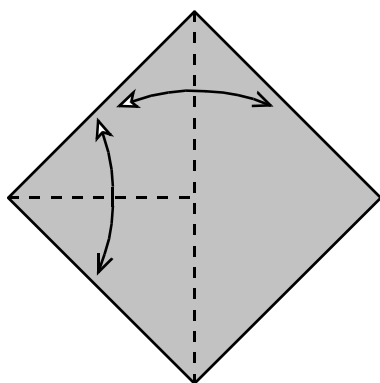

1. Crease the face colored side of paper or foil.

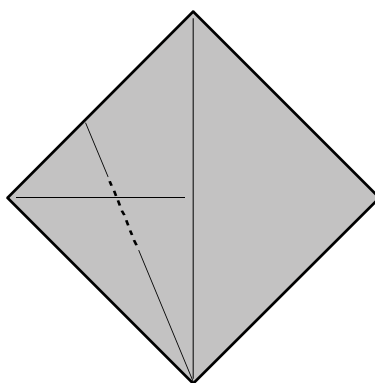

2. Crease an angle bisector at the horizontal diagonal and slightly below it.

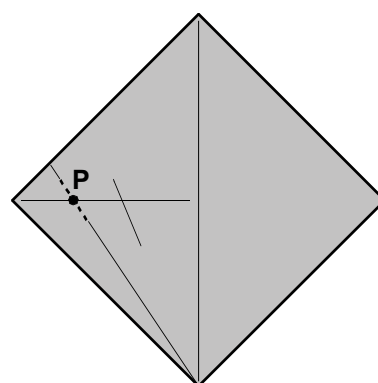

3. Bisect angle once more, creasing only at point P on the diagonal.

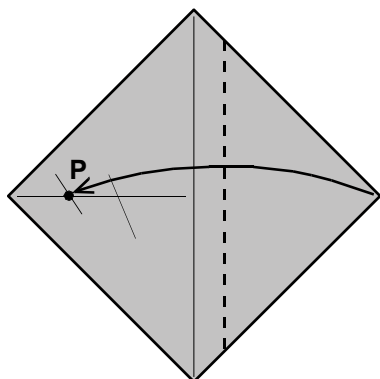

4. Valley-fold the right corner to point P.

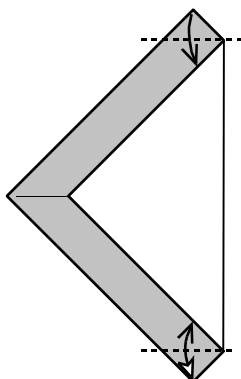

5. Fold the top corner down. Fold and unfold the bottom corner up.

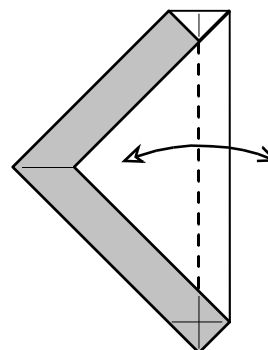

6. Valley-fold and unfold along the midline.



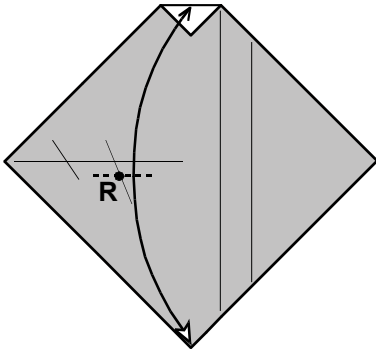

7. Put the bottom corner on the midline at the top. Pinch on the crease of step 2 at point R.

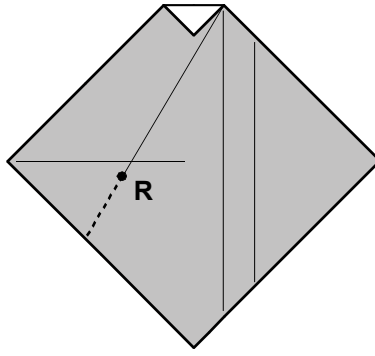

8. Define a line from the right side of the white triangle through point R. Valley-crease the line below point R.

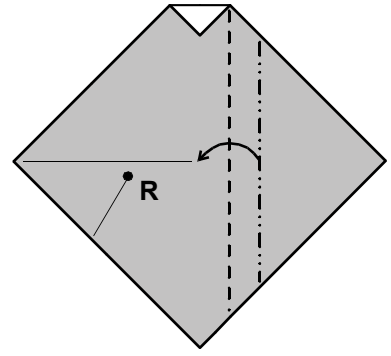

9. Pleat the right side on existing folds.

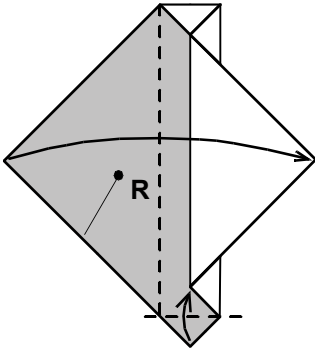

10. Fold the left corner to the right corner.

Fold the bottom corner up .

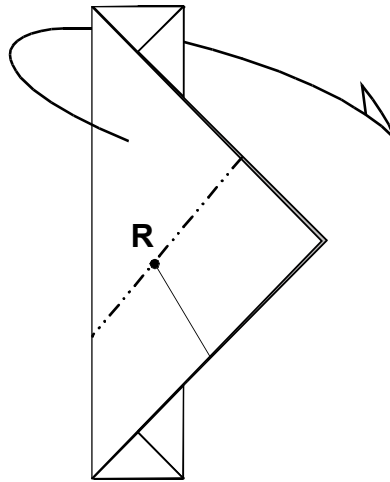

11. Mountain-fold the top half of the model behind on a line through point R.

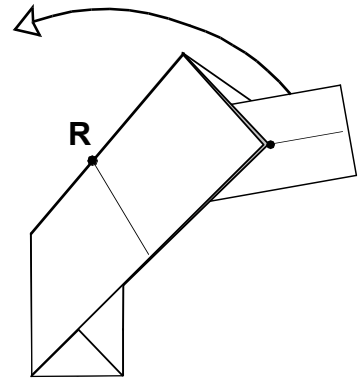

12. Adjust the fold by placing the corners on the midline of the model's reverse side (dot).

Unfold the last step.

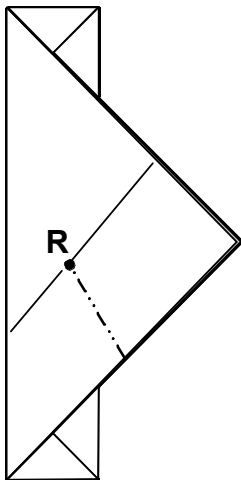

13. Mountain-fold the crease of step 8 through all layers.

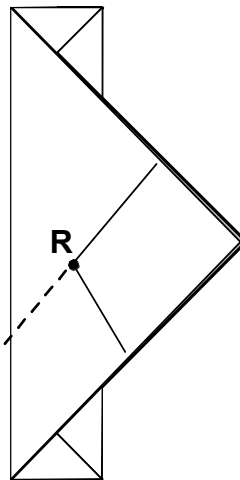

14. Change the mountain fold below point R to a valley fold.

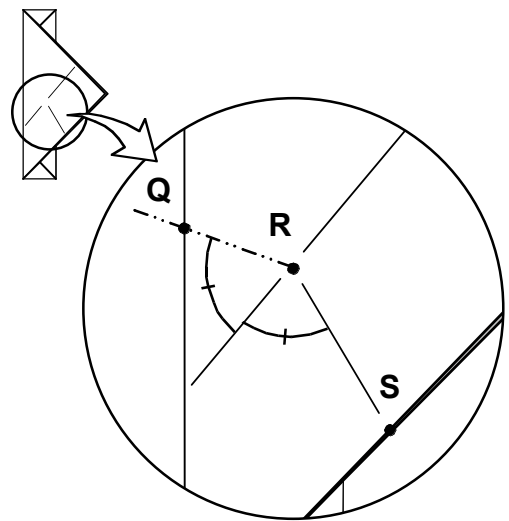

15. Create a mountain fold (line QR) through all layers . The valley fold of the last step bisects the angle QRS.



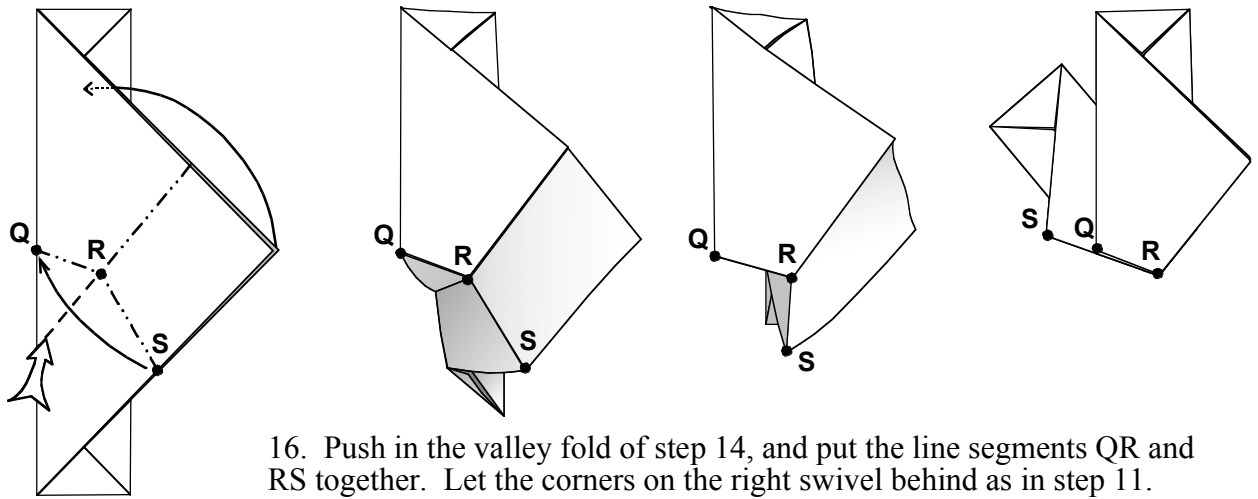

16. Push in the valley fold of step 14, and put the line segments QR and RS together. Let the corners on the right swivel behind as in step 11.

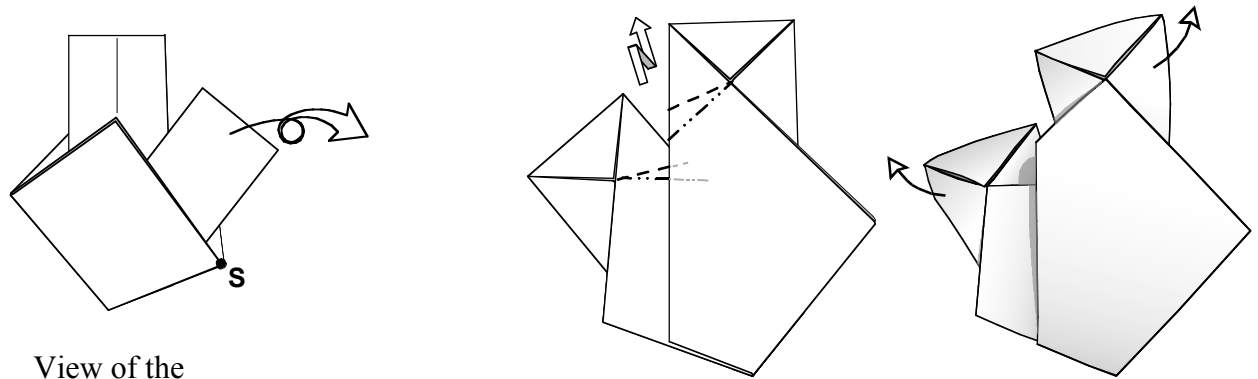

View of the reverse side.

17. Crimp the sides of the two owl heads and then undo the crimps.

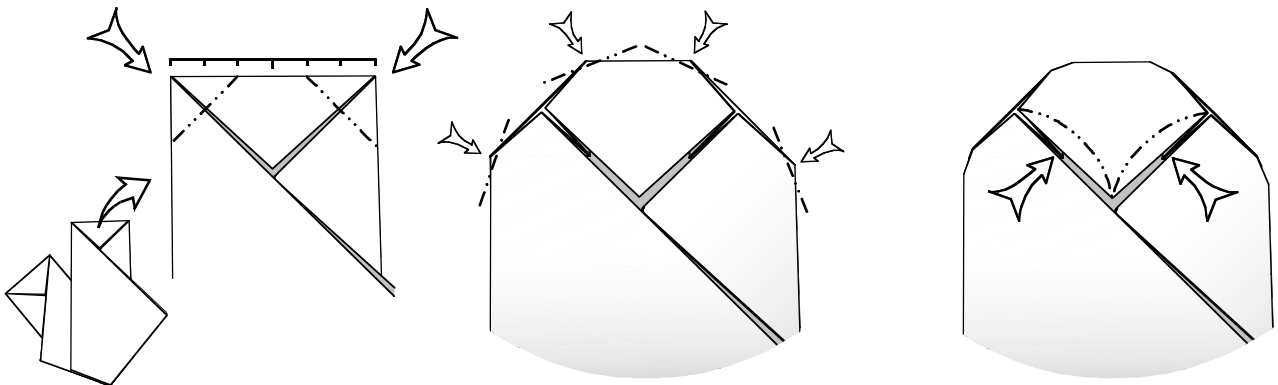

18. Open sink corners of the owl's head on the right.

19. Close sink edges to round the top of the head.

20. Shape the bill with curved mountain creases.

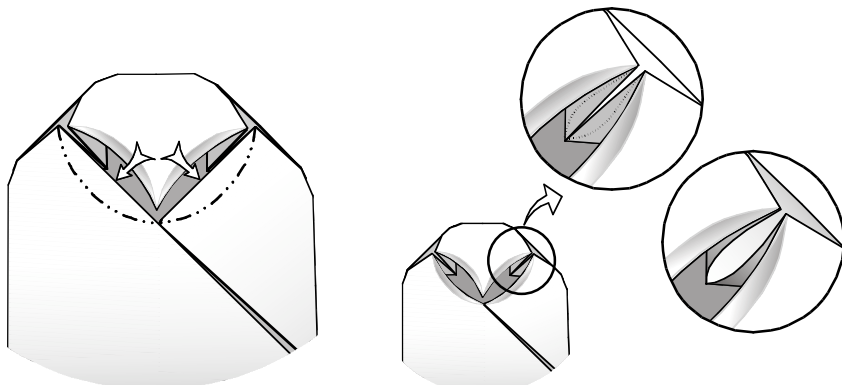

21. Shape the lower edges in a similar manner.

22. Spread apart edges to create eyes..

23. Shape the left eye and dent the top of the head.



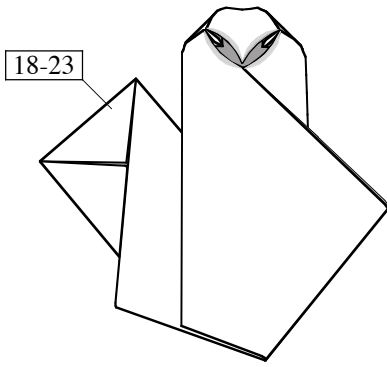

24. Repeat steps 18-23 on the other owl's head.

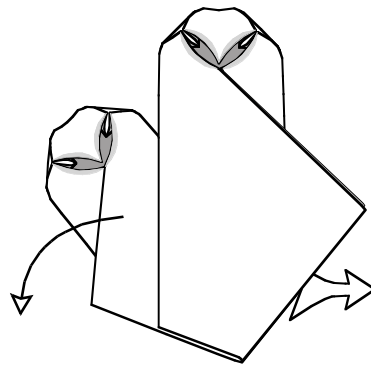

25. Unfold step 16.

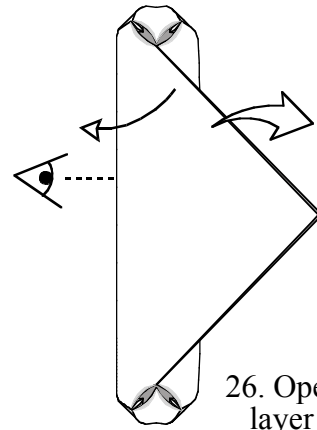

26. Open the top layer and view it from the folded edge.

back of the head

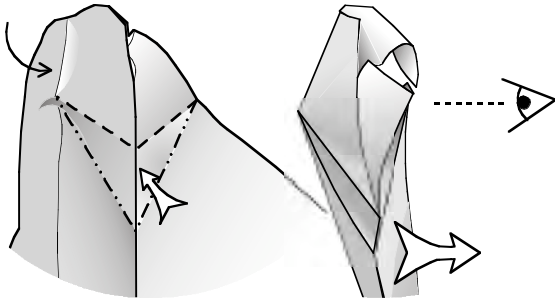

27. Change the direction of two folds on the back of the head and then symmetrically crimp the edge inside the model.

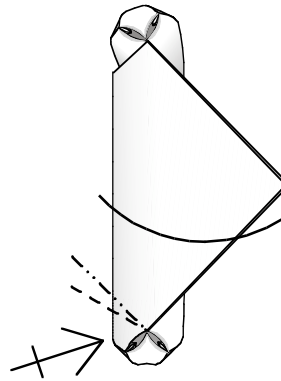

28. Repeat the last step on the other chick's head.

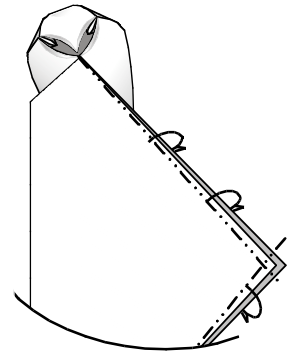

29. Put both flaps together and roll their edges behind.

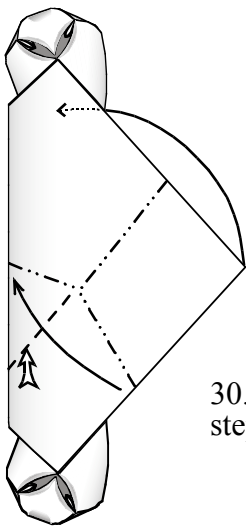

30. Refold step 16.

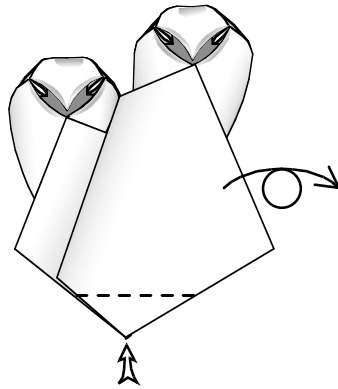

31. Close-sink the bottom and turn the model over.

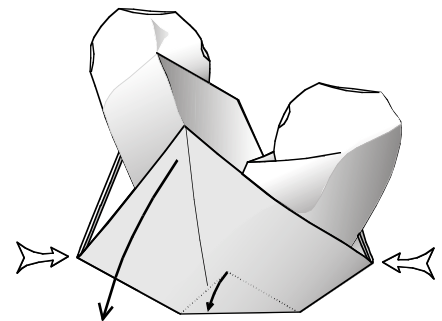

32. Fold the large flap and sink bottom down. The sides of the model will bend inward.

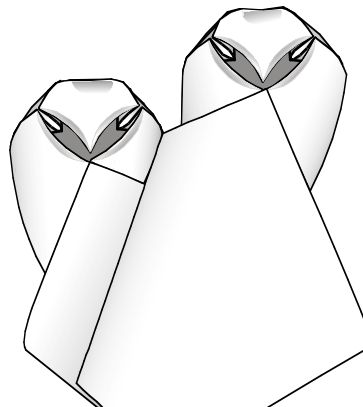
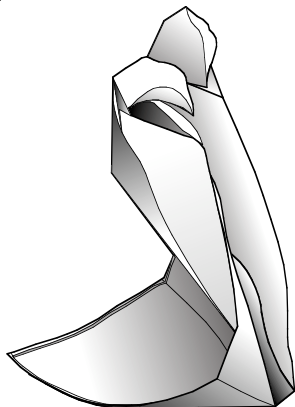

Completed owlets.

Don't worry if your owlets appear slightly different than these.

Just make them spooooooky!

